

Culligan®

**Culligan®
High
Efficiency
Softener-
Clear
and
Softener-
Clear Plus
Water
Conditioner
Owners
Guide**





Attention Culligan Customer

The installation, service and maintenance of this equipment should be rendered by a qualified and trained service technician. Your local independently operated Culligan dealer employs trained service and maintenance personnel who are experienced in the installation, function and repair of Culligan equipment. This publication is written specifically for these individuals and is intended for their use.

We encourage Culligan users to learn about Culligan products, but we believe that product knowledge is best obtained by consulting with your Culligan dealer. Untrained individuals who use this manual assume the risk of any resulting property damage or personal injury.



WARNING! Electrical shock hazard! Prior to servicing equipment, disconnect power supply to prevent electrical shock.

NOTE:

This system is not intended for use where water is microbiologically unsafe or with water of unknown quality.



WARNING! If incorrectly installed, operated or maintained, this product can cause severe injury. Those who install, operate, or maintain this product should be trained in its proper use, warned of its dangers, and should read the entire manual before attempting to install, operate, or maintain this product.



WARNING! This device complies with part 15 of the FCC rules subject to the two following conditions: 1) This device may not cause harmful interference, and 2) This device must accept all interference received including interference that may cause undesired operation.

This equipment complies with Part 15 of the FCC rules. Any changes or modifications not expressly approved by the manufacturer could void the user's authority to operate the equipment. Changes or modifications not expressly approved by the party responsible for compliance could void the user's authority to operate the equipment.



CAUTION! To reduce the risk of fire, use only No. 26 AWG or larger telecommunications line cord.



CAUTION! This product is not to be used by children or persons with reduced physical, sensory or mental capabilities, or lack of experience or knowledge, unless they have been given supervision or instruction.



CAUTION! Children should be instructed not to play with this appliance.



CAUTION! If the power cord from the transformer to the unit looks or becomes damaged, the cord and transformer should be replaced by a Culligan Service Agent or similarly qualified person in order to avoid a hazard.

Products manufactured and marketed by Culligan International Company (Culligan) and its affiliates are protected by patents issued or pending in the United States and other countries. Culligan reserves the right to change the specifications referred to in this literature at any time, without prior notice. Culligan, AquaSensor, Tripl-Hull, and SoftMinder are trademarks of Culligan International Company or its affiliates.

Culligan International Company
9399 West Higgins Road, Suite 1100
Rosemont, Illinois 60018
1-847-430-2800
www.culligan.com



Contents

About this Manual	4
Thank You.....	5
Specifications	6
Introduction.....	8
Application.....	9
The Culligan Process	10
Modes of Operation	12
Salt Supply, Usage and Service	13
Care and Cleaning of Your Water Conditioner	14
Cleaning Out the Salt Storage Tank	15
First Time Setup	16
Set Date and Time.....	19
Information.....	21
Regeneration	23
Error Codes	25
Sanitizing Procedure	27
When and How to Bypass Your Water Conditioner	28
Things to Check Before You Call for Service.....	29
Navigating the Menus and Keypad.....	30
Performance Data Sheet.....	32
Culligan HE 9" Softener-Clear Water Conditioner	32
Culligan HE 10" Softener-Clear Water Conditioner	33
Culligan HE 12" Softener-Clear Water Conditioner	34
Culligan HE 14" Softener-Clear Water Conditioner	35
Culligan HE 9" Softener-Clear Plus Water Conditioner	36
Culligan HE 10" Softener-Clear Plus Water Conditioner	37
Culligan HE 12" Softener-Clear Plus Water Conditioner	38
Culligan HE 14" Softener-Clear Plus Water Conditioner	39
Culligan Limited Warranty	40



About this Manual

This manual:

- familiarizes the operator with the equipment
- explains installation and setup procedures
- provides basic programming information
- explains the various modes of operation
- gives specifications and troubleshooting information

Read this Manual First

Before you operate the Culligan High Efficiency Softener-Cleer or Softener-Cleer Plus Water Conditioner, read this manual to become familiar with the device and its capabilities.

Installation or maintenance done on this system by an untrained service person can cause major damage to equipment or property damage. Not adhering to the recommended service/maintenance can cause damage to equipment or property damage.

Safe Practices

Throughout this manual there are paragraphs set off by special headings.

Notice (or Note) is used to emphasize installation, operation or maintenance information which is important, but does not present any hazard. For example,

NOTICE The nipple must extend no more than 1 inch above the cover plate.

Caution is used when failure to follow directions could result in damage to equipment or property.



CAUTION! Disassembly while under water pressure can result in flooding.

Warning is used to indicate a hazard which could cause injury or death if ignored.



WARNING! Electrical shock hazard!
Unplug the unit before removing the timer mechanism or cover plates!

The CAUTION and WARNING paragraphs are not meant to cover all possible conditions and situations that may occur. Understand that common sense, caution, and careful attention are conditions which cannot be built into the equipment. These MUST be supplied by the personnel installing, operating, or maintaining the system.

Be sure to check and follow the applicable plumbing codes and ordinances when installing this equipment. Local codes may prohibit the discharge of sanitizing or descaling solutions to drain.

Use protective clothing and proper face or eye protection equipment when handling chemicals or tools.

NOTE: The Culligan High Efficiency Softener-Cleer and Softener-Cleer Plus Water Conditioners are not intended for use with water that is microbiologically unsafe or of unknown quality without adequate disinfection either before or after the system.

NOTE: Check with your public works department for applicable local plumbing and sanitation codes. Follow local codes if they differ from the standards used in this manual. To ensure proper and efficient operation of the High Efficiency Softener-Cleer and Softener-Cleer Plus Water Conditioners to your full satisfaction, carefully follow the instructions in this manual.



Welcome To Your New World of Better Living with Culligan Water.

The High Efficiency Softener-Cleer and Softener-Cleer Plus Softeners are tested and certified by WQA against CSA B483.1, NSF/ANSI/CAN Standard 61, NSF/ANSI Standard 372, NSF/ANSI Standard 44 for the effective reduction of hardness (calcium and magnesium), and NSF/ANSI 42 for the effective Iron Reduction up to 10ppm, as verified and substantiated by test data.



If this is your first experience having soft, conditioned water in your home, you'll be amazed at the marvelous difference it makes. We promise that you'll never want to be without it again.

Congratulations, too, on selecting one of the "first family" of water conditioners in the prestigious Culligan High Efficiency Water Conditioners. With Culligan's many years of knowledge and experience in water treatment, you can be confident that the model you selected has been designed and engineered to provide years of service with a minimum of care and attention.

Some localities have corrosive water. A water softener cannot correct this problem and so its written warranty disclaims liability for corrosion of plumbing lines, fixtures or appliances. If you suspect corrosion, your Culligan Dealer has equipment to control the problem.

NOTICE **Sodium Information: Water softeners using sodium chloride for regeneration add sodium to the water. Persons who are on sodium restricted diets should consider the added sodium as part of their overall sodium intake.**

Serial Numbers

The control valve serial number is located on the back of the electrical enclosure.

The media tank serial number is located on the top surface of the tank.

NOTE: **DO NOT remove or destroy the serial number. It must be referenced on request for warranty repair or replacement.**

Thank You



Specifications

Culligan High Efficiency Softener-Cleer

Model	9" Model	10" Model	12" Model	14" Model
Control Valve	1" Reinforced Thermoplastic w/ HE Circuit Board			
Overall Softener Ht	56 in	62 in	60 in	73 in
Media Tank Design	Quadra-Hull™			
Media Tank Dimensions (Dia x Ht)	9 x 48 in	10 x 54 in	12 x 52 in	14 x 65 in
Salt Storage Tank Dimensions (Dia x Ht)	16 x 43 in or 18 x 43 in		18 x 43 in	24 x 42 in
Exchange Media, Type and Quantity	Cullex® Media, 1.0 ft³	Cullex Media, 1.5 ft³	Cullex Media, 2.0 ft³	Cullex Media, 3.0 ft³
Underbedding, Type and Quantity	Cullsán® Underbedding, 12 lb	Cullsán Underbedding, 15 lb	Cullsán Underbedding, 20 lb	Cullsán Underbedding, 25 lb
Exchange Capacity @ Salt Dosage Per Recharge	17,854 gr @ 4.0 lb	26,781 gr @ 6.0 lb	31,352 gr @ 7.0 lb	42,548 gr @ 10.5 lb
	27,108 gr @ 8.0 lb	40,662 gr @ 12.0 lb	48,458 gr @ 16.0 lb	67,146 gr @ 24 lb
	31,736 gr @ 12.0 lb	47,604 gr @ 18.0 lb	59,267 gr @ 24.0 lb	87,987 gr @ 36 lb
Efficiency rated dosage ¹	4,463 gr/lb @ 4 lb salt dosage	4,463 gr/lb @ 6 lb salt dosage	4,479 gr/lb @ 7 lb salt dosage	4,052 gr/lb @ 10.5 lb salt dosage
Freeboard to Media ²	14.5 in	14.5 in	16 in	25 in
Freeboard to Underbedding ³	44.5 in	47.5 in	46 in	59 in
Salt Storage Capacity	375 lb			600 lb
Rated Service Flow @ Pressure Drop	9.0 gpm @ 12 psi	9.4 gpm @ 13 psi	10.0 gpm @ 11 psi	10.6 gpm @ 11 psi
Auxiliary Flow Rate ⁴	10.8 gpm @ 15 psi	11.0 gpm @ 15 psi	12.6 gpm @ 15 psi	12.8 gpm @ 15 psi
Total Hardness, Max.	50 gpg	75 gpg		
Total Dissolved Iron, Max 10 ppm ⁵	2000 gal	3000 gal	4000 gal	6000 gal
Flow Rate for Iron Reduction ⁶	9.0 gpm	9.4 gpm	10.0 gpm	10.6 gpm
Iron and Sulfur Reducing Bacteria ⁸	Trace Amounts			
pH	6.5–8.5			
Tannins	0.0 ppm			
Total Organic Carbon	0.0 ppm			
Free Chlorine Level	0.0 ppm			
Dissolved Oxygen	3.0 ppm or below			
Polyphosphate	0.0 ppm			
Operating Pressure	20-125 psi (138–862 kPa)			
Operating Pressure (Canada)	20-90 psi (138–621 kPa)			
Operating Temperature	33-120°F (0–49°C)			
Electrical Requirements	28 VDC/60 Hz			
Electrical Power Consumption, Min/Max	8.4 watts/21.6 watts			
Drain Flow, Maximum ⁶	2.38 gpm	2.5 gpm	3.5 gpm	5.3 gpm
Recharge Time, Average ⁷ Recharge Water	78 minutes	67 minutes	62 minutes	76 minutes
Consumption, Average ⁷	58.1 gallons	65.1 gallons	108.2 gallons	167.1 gallons

¹The efficiency rated dosage is only valid at the stated salt dosage and is efficiency rated according to NSF/ANSI 44. Water consumption determined in accordance with 7.1.1 of NSF/ANSI 44.

²Measured from top of media to top surface of tank threads. (backwashed and drained).

³Measured from top of underbedding to top surface of tank threads.

⁴Auxiliary flow rates do not represent the maximum service flow rate used for determining the softener's rated capacity and efficiency. Continuous operation at these flow rates greater than the maximum service flow rate might affect capacity and efficiency performances.

⁵Performance testing on these models was performed at the flow rates specified. When a higher flow rate occurs upon installation, a flow control, restrictor, or other method of flow reduction should be used in order to mimic these performance results.

⁶Backwash at 120 psi (830 kPa).

⁷10 minute backwash, 4 lb 9" model, 6 lb. 10" model, 7 lb. 12" model or 12 lb. 14" model salt dosage.

⁸The Iron and Sulfur reducing bacteria performance is a manufacturer claim and has not been evaluated or certified by WQA.



Culligan High Efficiency Softener-Clear Plus

Model	9" Model	10" Model	12" Model	14" Model
Control Valve	1" Reinforced Thermoplastic w/ HE Circuit Board			
Overall Softener Ht	56 in	62 in	60 in	73 in
Media Tank Design	Quadra-Hull™			
Media Tank Dimensions (Dia x Ht)	9 x 48 in	10 x 54 in	12 x 52 in	14 x 65 in
Salt Storage Tank Dimensions (Dia x Ht)	16 x 43 in or 18 x 43 in		18 x 43 in	24 x 42 in
Exchange Media, Type and Quantity	Cullex® Media, 1.0 ft³	Cullex Media, 1.5 ft³	Cullex Media, 2.0 ft³	Cullex Media, 3.0 ft³
Underbedding, Type and Quantity	Cullsán® Underbedding, 12 lb	Cullsán Underbedding, 15 lb	Cullsán Underbedding, 20 lb	Cullsán Underbedding, 25 lb
Media, KDF-85	13.5 lb	13.5 lb	27.0 lb	40.5 lb
Exchange Capacity @ Salt Dosage Per Recharge	17,854 gr @ 4.0 lb	26,781 gr @ 6.0 lb	31,200 gr @ 7.0 lb	42,548 gr @ 10.5 lb
	27,108 gr @ 8.0 lb	40,662 gr @ 12.0 lb	44,764 gr @ 16.0 lb	67,146 gr @ 24 lb
	31,736 gr @ 12.0 lb	47,604 gr @ 18.0 lb	63,472 gr @ 24.0 lb	87,987 gr @ 36 lb
Efficiency rated dosage ⁷	4,463 gr/lb @ 4 lb salt dosage	4,463 gr/lb @ 6 lb salt dosage	4,457 gr/lb @ 7 lb salt dosage	4,052 gr/lb @ 10.5 lb salt dosage
Freeboard to Media ²	12 in	12 in	13.5 in	22.5 in
Freeboard to Underbedding ³	44.5 in	47.5 in	46 in	59 in
Salt Storage Capacity	375 lb			600 lb
Service Flow @ Pressure Drop	8.0 gpm @ 9.5 psi	9.9 gpm @ 14 psi	8.5 gpm @ 9 psi	11.0 gpm @ 15 psi
Auxiliary Flow Rate	10.7 gpm @ 15 psi	10.8 gpm @ 15 psi	11.7 gpm @ 15 psi	11.0 gpm @ 15 psi
Total Hardness, Max.	50 gpg	75 gpg		
Total Dissolved Iron, Max 10ppm ⁶	2000 gal	3000 gal	4000 gal	6000 gal
Flow Rate for Iron Reduction ⁶	4 gpm	5.9 gpm	8.5 gpm	11.0 gpm
Hydrogen Sulfide ¹	2 ppm			
Iron and Sulfur Reducing Bacteria ¹	Trace Amounts			
pH	6.5–8.5			
Tannins	0.0 ppm			
Total Organic Carbon	0.0 ppm			
Free Chlorine Level	0.0 ppm			
Dissolved Oxygen	3.0 ppm or below			
Polyphosphate	0.0 ppm			
Operating Pressure	20-125 psi (138–862 kPa)			
Operating Pressure (Canada)	20-90 psi (138–621 kPa)			
Operating Temperature	33-120°F (0–49°C)			
Electrical Requirements	28 VDC/60 Hz			
Electrical Power Consumption, Min/Max	8.4 watts/21.6 watts			
Drain Flow, Maximum ⁴	2.34 gpm	2.5 gpm	3.5 gpm	5.3 gpm
Recharge Time, Average ⁵ Recharge Water	78 minutes	67 minutes	62 minutes	76 minutes
Consumption, Average ⁵	58.1 gallons	65.1 gallons	108.2 gallons	167.1 gallons

¹The Hydrogen Sulfide and Iron and Sulfur reducing bacteria performance are manufacturer claims and have not been evaluated or certified by WQA.

²Measured from top of media to top surface of tank threads. (backwashed and drained).

³Measured from top of underbedding to top surface of tank threads.

⁴Backwash at 120 psi (830 kPa).

⁵10 minute backwash, 4 lb 9" model, 6 lb. 10" model, 7 lb. 12" model or 12 lb. 14" model salt dosage.

⁶Performance testing on these models was performed at the flow rates specified. When a higher flow rate occurs upon installation, a flow control, restrictor, or other method of flow reduction should be used in order to mimic these performance results.

⁷The efficiency rated dosage is only valid at the stated salt dosage and is efficiency rated according to NSF/ANSI 44.



Introduction

It's All So Easy, So Economical, So Efficient, So Enjoyable!

Kind To Skin And Complexion

Soft water will help prevent red, itchy or dry skin because there are no hardness impurities to cause soreness, no soap curd to coat the skin. Shaving is easier, smoother—either with a blade or electric shaver.

Bathing And Showering

You'll use far less soap with conditioned water. Use your soap very sparingly—not as you did before soft water. Just a quick rinse removes all lather, leaving your skin pleasantly smooth and silky because now it's free of sticky soap curd and film.

Saves Washing Costs. Helps Control Environmental Pollution

Soft water washes whiter and cleaner with less soap or detergent. Because the hardness impurities are removed, your soap can concentrate solely on washing. People usually find that they can reduce the amount of soap they use substantially. If you normally use a cup per wash load with hard water, try using 1/3 cup depending on the size of your wash load and the degree of soil. Different amounts are required, but you can use less with softened water. An added bonus is the fact that your washable fabrics will last longer.

Super Hair Conditioning

Soft water is great for scalp and hair care. No insoluble deposits are formed. Hair is shinier, softer, more manageable. Reduce the amount of shampoo you have normally used.

Dishes Are A Delight

Washed by hand or in a dishwasher, glassware, dishes and silver wash cleaner, easier. Follow your dishwasher manufacturer's instructions. Soft water promotes sanitation because no greasy hard water film can form to collect or harbor bacteria.

Easier Housekeeping, Gleaming Fixtures

You'll be amazed at the marvelous difference. Just a swish of the cloth, and the bathtub or shower and fixtures are clean and sparkling. Imagine, no scouring! No hard water scum to cause rings, streaks, spots and stains. To keep their gleaming luster, simply wipe fixtures with a towel after use. Formica, tile, walls, floors, woodwork surfaces clean easier, stay clean longer. You'll save on cleaning aids and save on time.

Saves Water-Heating Energy, Helps Water-Using Appliances

Soft water reduces the formation of rock-like hard water scale that encrusts water heaters, hot water pipes, shower heads, and water-using appliances. This scale can cause premature maintenance and failure.

Elimination of hard water also provides substantial energy savings because scale acts as an insulator, wasting electricity or gas used to heat water.

Water For Lawns And Household Plants

If possible, lawn sprinkling faucets should be supplied with hard water primarily because it is not economical to soften so much water.

Household plants are much more sensitive than lawns with respect to the kind of water which is best. First, because they receive no rainfall and, second, there is little or no drainage of the soil. Preferably they should be watered with rainwater or water which is low in mineral content such as distilled or demineralized water. Softened water is not recommended for house plants because a build-up of sodium in the soil may interfere with efficient absorption of water by the plant root system. Additional information may be obtained from your independently operated Culligan dealer.



Water Quality

Verify that raw water hardness and iron are within limits. Note the hardness for setting the salt dosage and recharge frequency.

Iron—A Common Water Problem

The chemical/physical nature of iron found in natural water supplies is exhibited in four general types:

1. **Dissolved Iron**—Also called ferrous or “clear water” iron. Up to 10 ppm of this type of iron can be removed from the water by the Softener-Cleer. Dissolved iron is soluble in water and is detected by taking a sample of the water to be treated in a clear glass. The water in the glass is initially clear, but on standing exposed to the air, it may gradually turn cloudy or colored as it oxidizes.
2. **Particulate Iron**—Also called ferric or colloidal iron. This type of iron is an undissolved particle of iron. Softener-Cleer will remove larger particles, but they may not be washed out in regeneration effectively and will eventually foul the ion exchange resin. A filtering treatment will be required to remove this type of iron.
3. **Organic Bound Iron**—This type of iron is strongly attached to an organic compound in the water. The ion exchange process alone cannot break this attachment, and Softener-Cleer will not remove this type of iron.
4. **Bacterial Iron**—This type of iron is protected inside a bacteria cell. Trace amounts of Bacterial Iron is inactivated by Softener-Cleer.

When using a softener to remove both hardness and up to 10 ppm of dissolved iron it is important that it regenerates more frequently than ordinarily would be calculated for hardness removal alone. This will minimize the potential for bed fouling.



CAUTION! Do not use where the water is microbiologically unsafe or with water of unknown quality without adequate disinfection before or after the unit.

Pressure

Do not operate the system at the maximum pressure rating of 125 psi. If water pressure is greater than 80 psi, Culligan recommends following the IAPMO Uniform Plumbing code section 806.2 by installing a Pressure Regulating Valve before the system. Operating on high pressure for extended periods of time can increase the service frequency of replacement parts. If water pressure can drop below the minimum water pressure, add a booster pump to increase it above the minimum operating pressure.



CAUTION! The use of a pressure reducing valve may limit the flow of water in the household.

Temperature

Do not install the unit where it might freeze, or next to a water heater or furnace or in direct sunlight. Outdoor installation is not recommended and voids the warranty. If installing in an outside location, you must take the steps necessary to assure the softener, installation plumbing, wiring, etc. are as well protected from the elements (sunlight, rain, wind, heat, cold), contamination, vandalism, etc. as when installed indoors.

Location—Space Requirements

Allow 6-12 inches (15-30 cm) behind the unit for plumbing and drain lines and 4 feet (1.3 meters) above for service access and filling the salt container.

Application



The Culligan Process

Your Culligan water conditioner consists of three basic components, (A) the Control Valve, (B) the Mineral Tank, and (C) the Brine System.

A. Control Valve

The exclusive Culligan control valve automatically performs a variety of tasks that are necessary for the proper operation of your water conditioner. These tasks, commonly referred to as cycles or operating positions, are **Service**, **Regeneration**, and **Brine Refill**.

1. **Service:** While the control valve is in the service cycle, hard water is directed down through the column of Cullex® resin where hardness minerals are removed from the water. The softened water is then directed into your household plumbing lines. The ability of the Cullex resin to remove hardness minerals needs to be periodically replenished; this is referred to as regeneration.
2. **Regeneration:** While the control valve is in the regeneration cycle, water is first directed up through the column of Cullex resin to flush accumulated sediment out of the resin and down the drain. Then, the regenerant brine solution is slowly drawn from the bottom of the salt storage tank of the Brine System and is directed down through the column of Cullex resin, restoring the ability of the resin to remove hardness minerals from your water supply. Once completed, the regeneration cycle is followed by mineral reactivation.

Mineral Reactivator: The Mineral Reactivator is educted for a specified duration during the Brine Draw cycle. The Mineral Reactivator is designed to clean the Cullex resin pores of iron, manganese, and organic compounds that cause resin fouling and inefficiencies.

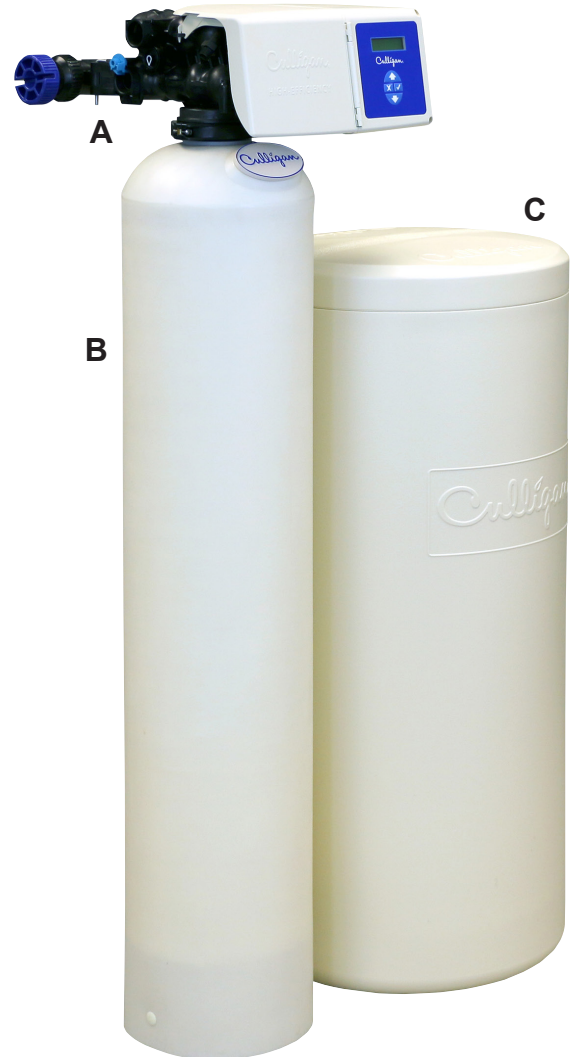

NOTE: Contact your Culligan dealer when you need to replenish the Mineral Reactivator.

Chlorine Generator: Chlorine is generated from the brine solution and then is added after the eduction of the Mineral Reactivator. The chlorine inactivates trace amounts of iron-reducing bacteria and sulfur-reducing bacteria.

3. **Brine Refill:** While the control valve is in the brine refill cycle, a predetermined amount of water is directed to the salt storage tank of the Brine System so that additional salt can be dissolved to provide the brine solution that will be needed for the next regeneration cycle.



Softener-Clear Regeneration Sequence

See [Figure 1](#) for an overview of the Softener-Clear regeneration sequence.

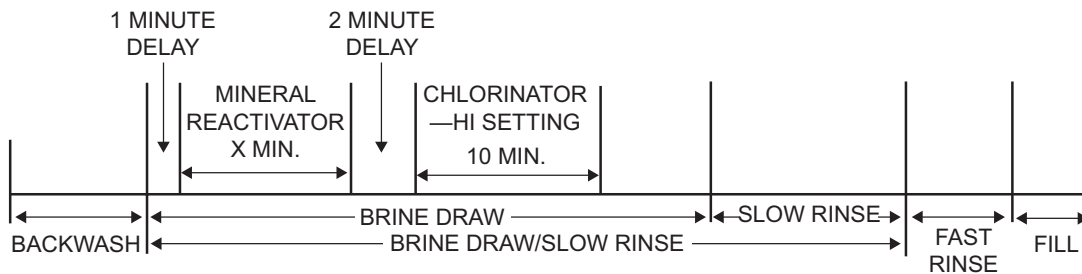

Figure 1. Softener-Clear regeneration sequence.

B. The Mineral Tank

The Mineral Tank contains the Cullex resin column, Cullsian® underbedding, and an outlet manifold. The number of gallons of hard water that can be softened by the Cullex resin column before it needs regeneration is called the “capacity” of the resin column, and depends upon the amount of hardness minerals in each gallon of water (expressed as grains per gallon) and upon the amount of regenerant brine solution (expressed as pounds of salt) passed through the resin column during regeneration.

Your Culligan service person, taking into account the hardness of your water and the amount of softened water your household may reasonably expect to use each day, has carefully established how often the softener will regenerate and how much salt will be used for each regeneration. This will ensure that all of your soft water needs will be fulfilled without using an excessive amount of salt.

KDF (Softener-Clear Plus Models Only):

KDF media reduces hydrogen sulfide.

C. The Brine System

The Brine System consists of a salt storage container and hydraulic Dubl-Safe™ valve. The salt storage container holds the salt that is used to make the regenerant brine solution. The hydraulic Dubl-Safe valve limits the amount of water that is returned to the salt storage tank during the brine refill cycle.

Because a predetermined amount of salt is dissolved with each brine refill cycle, the salt must be periodically replenished in order to maintain efficient operation. Your Culligan service person will be able to tell you about how often salt must be added to the salt storage container.



Modes of Operation

Water Meter

The water meter keeps track of the quantity of water that has flowed through the resin bed. Based on the influent water hardness and the hardness capacity of the resin bed, a service life expectancy in the quantity of softened water is calculated and programmed into the control. When the set point is reached, regeneration is triggered. The regeneration will start at time of regeneration (typically 2:00 a.m.). In immediate mode the regeneration starts as soon as the regeneration signal is provided. If time clock backup is set and the capacity has not been exhausted, but the days since last regen is greater than the time clock backup setting, the softener will regenerate.

Smart Brine Tank Probe

The optional smart brine tank probe monitors conditions inside the brine tank. It predicts when salt needs to be added to the brine tank, detects the presence of salt-bridging, eductor line plugging and brine tank overfilling.

Wireless Remote Control

The optional wireless remote control displays the current status of the water softener or filters and allows for remote control. It can be located up to 200 feet away from the softener (depending upon building construction materials). The wireless remote displays information about softener performance, problems, days of salt remaining and allows remote control for regeneration.

The wireless remote control is designed to communicate at 915 MHz and to work without interference with other 915 MHz devices such as cordless telephones and baby monitors.



Modem

The optional modem allows for the system to be remotely monitored detecting problems before they occur, to schedule salt delivery when it is needed and to keep the system software up to date with the latest advances.

Culligan Connect™

The Culligan Connect™ interface is an intuitive mobile app and is available on both iOS and Android. Users will see their daily and weekly usage patterns graphically represented and instantly updated each time they open the app. In addition, low salt alerts and the ability to put the unit in bypass mode or regeneration from anywhere offer an all new level of control and convenience.

Manual Regeneration

Manual regeneration can be initiated via the softener control valve or wireless remote display. Manual regeneration can be initiated to begin regeneration immediately or that night. To immediately initiate regeneration, press and hold  for at least ten (10) seconds. To cancel a delayed regeneration, press and hold  for at least five (5) seconds.



Salt Supply, Usage and Service

Salt is the mineral used to “recharge” your water conditioner. A brine solution is automatically made up in the bottom of the salt storage container, the Cullex® resin beads in the mineral tank are flushed with the brine solution as a step in the recharging process.

Your Culligan Water Conditioner has been carefully designed to get the greatest amount of softening capacity from the salt it uses. Here is some pertinent information about salt usage, types and service.

Salt Economizer

This control is set at the time of installation, and determines salt usage according to the water hardness, number of persons in the household, and water usage.

What Kind of Salt is Best

All Culligan Water Conditioners are designed to use any water conditioner salt of good quality, including rock, pellet, solar, or “evaporated” types.

All rock salt, regardless of source, contains insoluble material which collects at the bottom of the salt storage tank and requires periodic clean-out.

If purified salt products are used, the salt storage compartment will require less frequent clean-out, but you must check more frequently for “bridging.”

Regardless of what type of salt is used, we recommend Culligan Brand Salt as suggested by your Culligan Dealer. He or she is the expert and can provide you with the best product for your Culligan Water Conditioner.

Automatic Salt Delivery Service

Ask your Culligan Dealer for details about salt delivery service. You can have your salt supply replenished on a regular basis. Whether you have automatic delivery service or pick up salt from your Culligan Dealer, you will be getting quality salt packaged according to rigid Culligan specifications. Using Culligan Brand Salt will help assure continued efficiency and trouble-free operation of your water conditioner.

The modem allows for the system to be remotely monitored, detecting problems before they occur, to schedule salt delivery when it is needed and to keep the system software up to date with the latest advances.

NOTICE Sodium Information: Water softeners using sodium chloride for regeneration add sodium to the water. Persons who are on sodium restricted diets should consider the added sodium as part of their overall sodium intake.



Care and Cleaning of Your Water Conditioner

Following these simple precautions will help assure continued trouble-free service and keep your Culligan Water Conditioner looking like new for years.

1. Do not place heavy objects on top of the salt storage tank or timer cover.
2. Use only mild soap and warm water when cleaning the exterior of the conditioner. Never use harsh, abrasive cleaning compounds or those which contain acid, such as vinegar, bleach and similar products.
3. Important: Protect your water conditioner and the entire drainline from freezing temperatures.



WARNING! DANGER: If your unit should freeze, do not attempt to disassemble it. Call your Culligan Dealer.

4. Important: Culligan water softeners are sold for use on potable water only. If at any time the water becomes contaminated, such as during a “boil water” advisory, the operation of the water softener should be discontinued until it is verified that the water is again potable. To do this, turn the blue knob in a clockwise position, then call your Culligan dealer to have your system sanitized before it is placed back into service.
5. Should service, adjustment or trouble-shooting information be needed which is not covered in the Use and Care Guide, call your Culligan Dealer.

For parts and service availability please call your local independently operated Culligan dealer. For your nearest Culligan dealer, call (800) 285-5442.

Recommended Preventative Maintenance Inspection Schedule

The Culligan High Efficiency household water softener has been designed to provide a good, consistent service life. Routinely inspecting the system may help avoid potentially costly breakdowns related to circumstances outside of the control of the dealer and/or user.

Component	Suggested Inspection Frequency	Reason for Maintenance
Entire System	At Start-up, after infrequent use (idle for one week or more) or every 3–6 months.	On private supplies, the appearance of off-tastes and odors, particularly if musty or “rotten egg” (caused by harmless sulfate-reducing bacteria) may indicate a need for the system to be sanitized. See page 48.
Backwash Flow Controller	Every 12 months or every time service is performed on the system.	Build up of sediment, iron and/or other foreign materials (found in some water supplies but not necessarily all) could negatively affect system performance. Monitor item for normal or unexpected wear.
Brine eductor nozzle and throat	Every 12 months or every time service is performed on the system.	Build up of sediment, iron and/or other foreign materials (found in some water supplies but not necessarily all) could negatively affect system performance. Monitor item for normal or unexpected wear.
Softening Media (Cullex)	Every 2–3 years	Chlorinated water supplies can breakdown and destroy resin material. Resin material may also perform poorly if subjected to other materials (sediment, iron, alum, etc.) found in some water supplies (but not necessarily all).



Cleaning Out the Salt Storage Tank

A periodic clean-out of the Salt Storage Tank is necessary to keep your Culligan Water Conditioner at peak operating efficiency. Do it at least every two years when the salt supply is low.

Follow these step-by-step procedures:

Tools Needed

- Scoop
- Clean, bucket-size container
- Garden hose
- Household scrub brush or sponge

Procedure

1. Remove the salt storage tank cover and the cap from the brine valve chamber.
2. Disconnect the brine line from the brine valve by holding the outer ring of the push fitting; push the tubing in slightly before pulling it out.
3. Lift the brine valve out of the brine valve chamber and set aside in an upright position.
4. If you'd like to save any clean, dry salt remaining in the tank, remove it and place it in a clean container.
5. Using the scoop, dig out and discard as much remaining salt, water and debris as possible.
6. Remove the brine valve chamber by removing the screws on either side of the salt tank.
7. Remove the salt plate at the bottom of the brine tank.
8. Lay the salt tank on its side and direct a brisk stream of water from your garden hose to its inside to rinse out all residue.
9. Using a household scrub brush and a mild soapy solution, clean the salt plate. This will complete the tank cleaning.
10. Insert the brine valve into the chamber and replace brine valve chamber cap. (Re-insert the brine valve into the chamber, re-insert the brine line fully, and replace brine valve chamber cap.)
11. Fill the salt storage tank with 4 to 6 inches of water.
12. Fill the tank with salt to within a few inches of the top.
13. Replace salt storage tank cover.



First Time Setup

First Time Setup Procedure

When a new controller is first powered on, the screen will display the first time setup message. The HE Controller is designed to simplify the setup and installation process by making some default recommendations during the initial setup. These default settings are appropriate for most common installations. After completing the plumbing connections to the water softener, turn on and program the HE Controller.

FIRST TIME SETUP
PRESS DOWN ARROW

When a new controller is first turned on, the screen displays **FIRST TIME SETUP**. Press  to display the first setup screen.

Serial Number

S/N: 00000123

The screen displays the serial number for this Smart Controller. Press  to display the firmware version information screen.

NOTE: If this unit will be installed with a modem, it is required that this electronic ID number be reported to Culligan on the IQR form.

Firmware Version



FWR***LT21
MON DD YEAR

The screen displays the firmware version and date installed for this Smart Controller.

Press  to display the month setup screen.

Set Month (Jan–Dec)



SET MONTH
>JAN



The screen displays the month setting. Press  to accept the information displayed (and view the next setting), or press  to change the setting.

Press  to accept the selected month and advance to the next setting, **SET DAY**.

Set Day (0–31)

SET DAY
>1

The screen displays the day setting. Press  to accept the information displayed (and view the next setup screen), or press  to change the setting.

Press  to see the next available value. Press  to accept the selected day and advance to the next setting, **SET YEAR**.



Set Year (2009–2030)

SET YEAR
>2019

The screen displays the year setting. Press to accept the information displayed (and view the next setup screen), or press to change the setting.

Press to see the next available value. Press to accept the selected year and advance to the next setting, **CLOCK TYPE**.

Set Clock Type (12 or 24)

CLOCK TYPE
>12 HR

The screen displays the clock type setting. Press to accept the information displayed (and view the next setup screen), or press to change the setting.

Press to change the clock type from 12-hour to 24-hour. Press to accept the selected clock type and advance to the next setting, **SET HOUR**.

Set Hour (12PM–11AM)

SET HOUR
>12AM

The screen displays the hour setting. Press to accept the information displayed (and view the next setup screen), or press to change the setting.

Press to change the hour (in this example, from 12PM to 10AM). Press to accept the selected hour and advance to the next setting, **SET MINUTES**.

Set Minutes (0–60)

SET MINUTES
>01

The screen displays the minutes setting. Press to accept the information displayed (and view the next setup screen), or press to change the setting.

Press to change the minutes (in this example, from 0 to 20). Press to accept the selected hour and advance to the next setting, **UNIT TYPE**.

Unit Type (Softener, Filter, or Resin + Carbon)

UNIT TYPE
>SOFTENER

The screen displays the unit type setting. Press to accept the default setting (softener) and advance to the next setting, **VALVE TYPE**.

Valve Type

(HE 1, HE 1.25, HE 1.5, HE 1 Twin, HE 1.5 Twin, 4-Cycle, 5-Cycle, or Plat Plus)

VALVE TYPE
>HE 1

The screen displays the valve type setting. Press to accept the default setting (HE 1) and advance to the next setting, **UNITS**.



Units (US or Metric)

UNITS
>US

The screen displays the units of measure setting. Press to accept the default setting (US) and advance to the next setting, INSTALL TYPE.

Install Type (Residential or Commercial)

INSTALL TYPE
>Residential

The screen displays the installation type setting. Keep this at the default, Residential. Press to view the next setting, BRINING TYPE.

Brining Type (Downflow, Upflow, Proportional)

BRINING TYPE
>Downflow

The screen displays the brining type setting. Press or and then to change this setting to Downflow and view the next setting, TANK DIAMETER.

Tank Diameter (9, 10, 12, 14)

TANK DIAMETER
>10

The screen displays the tank diameter setting. Press or and then to change the value and view the next setting, WATER HARDNESS.

Water Hardness (1–170)

HARDNESS GPG
25 (1109 GAL)

The screen displays the water hardness setting in grains per gallon. Press or and then to change the value and begin initialization.

Completed First Time Setup

Initializing
JAN-01-19 12:01P

When the setup is complete, the circuit board microprocessor automatically calculates softener capacity. The screen displays the initializing status and the current date and time, and then transitions to the home screen.

SOFTENING
JAN-01-19 12:01P

The screen displays the current state (the display alternates between Softening and any error) and the date/time set for the unit. This is the default home screen.

The controller is designed to simplify the setup and installation process by making some default recommendations during the Initial Setup. The default settings are designed to be appropriate for most common installations.







Set Date and Time

Follow this procedure to update the date or time.

NOTE: The control must be returned to the HOME screen if settings are changed.

Screen Display	Range	Setting Description
SOFTENING JAN-01-19 12:01P	N/A	1. From the HOME screen, press to view the main menu.
>1) INFORMATION 2) MANUAL MODE	1-6	2. The screen displays the main menu. Press to select 3) SET DATE/TIME .
Set Month		
SET MONTH >JAN	Jan- Dec	3. The screen displays the month setting. Press or and then to change the setting.
Set Day		
SET DAY >1	1-31	4. The screen displays the day setting. Press or and then to change the setting.
Set Year		
SET YEAR >2019	2009- 2030	5. The screen displays the year setting. Press or and then to change the setting.
Set Clock Type		
CLOCK TYPE > 12 HR	12 HR, 24 HR	6. The screen displays the clock type setting. Press or and then to change the setting.
Set Hour		
SET HOUR > 12PM	12PM- 11AM, 0-23	7. The screen displays the hour setting. Press or and then to change the setting.
Set Minutes		
SET MINUTES >01	0-59	8. The screen displays the minutes setting. Press or and then to change the setting.



Screen Display	Range	Setting Description
Set Daylight Savings Time		
<div style="border: 1px solid black; padding: 5px;"> DAYLIGHT SAVING YES </div>	Yes, No	9. The screen displays the Daylight Savings Time setting. Press   or  and then  to change the setting.
<div style="border: 1px solid black; padding: 5px;"> 2) MANUAL MODE >3) SET DATE/ TIME </div>		10. The screen displays the main menu. Press  to save the changes and initialize the system.
<div style="border: 1px solid black; padding: 5px;"> SOFTENING JAN-01-19 12:01P </div>		11. The screen displays the home screen.







Information

The following information can be displayed at the control valve or remote display. These settings are read-only. Press or to scroll through the settings. Press to view the previous setting.

Screen Display	Range	Setting Description
SOFTENING JAN-01-19 12:01P	N/A	1. From the HOME screen, press to view the main menu.
>1) INFORMATION 2) MANUAL MODE	1-6	2. The screen displays the main menu. Press to select 1) INFORMATION .
SALT TANK LEVEL OK	OK, Low	3. If a Smart Brine Tank Probe is installed, this screen displays the salt level. The status is OK unless the SBT probe detects low salt level. If the screen displays LOW a subsequent screen displays APPROX DAYS OF SALT REMAINING . Press to select the next information screen.
REMAIN CAPACITY 100%	0-100	4. The screen displays the softening capacity remaining, displayed as a percentage of the total capacity. During manually initiated regeneration, assume 0 percent remaining capacity. Press to select the next information screen.
REMAIN CAPACITY 740 GAL	0-no limit	5. The screen displays the softening capacity remaining, measured in gallons (liters). Press to see the next information screen.
CURRENT FLOWRATE 0.0 GPM	0-no limit	6. The screen displays the current flow rate, measured in gallons (liters) per minute. Press to see the next information screen.
TODAY'S USAGE 0 GAL	0-no limit	7. The screen displays today's water usage, measured in gallons (liters). Press to see the next information screen.



Screen Display	Range	Setting Description
AVERAGE DAILY 300 GAL	0–no limit	8. The screen displays average water usage for this configuration. Press  to see the next information screen.
NEXT REGEN ON JAN-03	N/A	9. The screen displays the date of the next regeneration, based on average daily water usage. Press  to see the next information screen.
TOTAL WATER USED 1000 GAL	0–no limit	10. The screen the total water used for this configuration. Whole numbers are displayed above 100 gallons. Press  to see the next information screen.
EXT FILT CAP REM 20000 GAL	0–no limit	11. If an external filter is used, the screen displays the remaining capacity of the filter. When the remaining capacity reaches zero, the system triggers the External Filter Alarm. Press  to return to the main menu.
>1) INFORMATION 2) MANUAL MODE		12. The screen displays the main menu. Press  to exit to the home screen.
SOFTENING JAN-01-19 12:01P		13. The screen displays the home screen.



Regeneration

There are several conditions that will cause the control to trip a regeneration. The screen displays REGEN Tonite when the control has signaled for a regeneration. Regenerating is displayed while the control is in regeneration. The following are conditions that will call for regeneration:

1. When the Soft-Minder® meter has recorded the passage of a predetermined number of gallons.
2. At the preset time, when the number of days without a regeneration is equal to the regeneration interval (timeclock backup) setting.
3. At the preset time, when Regen Tonite is selected. The screen displays Regen Tonite.
4. Immediately, when the Regen Now is selected. The screen displays Regenerating.
5. Immediately, if power to the unit has been off for more than three hours and the time of day has been restored.
6. At the preset time based on "Day-of-Week" Regeneration setting.

Follow either procedure to bypass the softener or to initiate a manual regeneration or automatically bypass the softener at the control valve or the remote display.

Delayed Regeneration

Screen Display	Range	Setting Description
SOFTENING JAN-01-19 12:01P	N/A	1. From the HOME screen, press <input checked="" type="checkbox"/> and hold for at least three (3)seconds and then release the button.
REGEN TONITE JAN-01-19 12:01P	Regen Tonite	2. The screen displays the regeneration status on the first line of the display. The system will regenerate at a scheduled time.
REGEN OFF JAN-01-19 12:01P	Regen Off	3. To cancel a delayed regeneration, press <input checked="" type="checkbox"/> and hold for at least three (3) seconds and then release the button. The screen displays the new status.

Immediate Regeneration

Screen Display	Range	Setting Description
SOFTENING JAN-01-19 12:01P	N/A	1. From the HOME screen, press <input checked="" type="checkbox"/> and hold for at least ten (10) seconds.
REGEN NOW JAN-01-19 12:01P	Regen Now	2. The screen displays the regeneration status on the first line of the display. The softener will initiate an immediate regeneration.
REGENERATING JAN-01-19 12:01P	N/A	3. The first line of the screen displays REGENERATING .



Standard Manual Regeneration

Screen Display	Range	Setting Description
SOFTENING JAN-01-19 12:01P	N/A	1. From the HOME screen, press to view the main menu.
1) INFORMATION >2) MANUAL MODE	1-6	2. The screen displays the main menu. Press to select 2) MANUAL MODE .
MANUAL MODE >REGEN NOW	Regen Off Regen Now Regen Tonite Bypass	3. The screen displays the manual regeneration menu. Press or and then to change the setting. REGEN NOW is the default. REGEN OFF specifies the softener will not regenerate. REGEN TONITE specifies that the softener will regenerate that night at 2:00 a.m. (or at the preset regeneration time). The screen displays two status messages: SOFTENING and REGEN TONITE . BYPASS specifies a preset softener bypass time. Press to select the total time the softener is in the bypass state.
MANUAL BYPASS OFF	Off, 30, 60, 90, 120, 180, Manual Bypass	4. The screen displays the manual bypass duration, in minutes. This specifies the total time the softener is to be in the bypass state. Press or and then to change the setting.
SOFTENING JAN-01-19 12:01P	N/A	5. Press to display the home screen.



Error Codes

The controller display, as well as the Remote Display (if connected), may display the following errors.

PROBLEM FOUND
APR-01-19 10:01A

1. When the controller identifies an error, it is programmed to attempt to correct the error without user input. If the problem persists, the **HOME SCREEN** displays **PROBLEM FOUND**. Press to display the first error present.

REPLACE FILTER
MEDIA

2. Press to display any additional errors present.

-->CLEAR ERRORS

3. Press and to view action: **CLEAR ERRORS**, **GO TO MENU**, or **EXIT**. If you select **CLEAR ERRORS**, the controller checks the error status and attempts to clear the error. If the error still exists, the home screen displays **PROBLEM FOUND**. If the error no longer exists the screen displays **SYSTEM OK**.

-->GO TO MENU

4. Press to select **CLEAR ERRORS**, **GO TO MENU**, or **EXIT**.

Error	Reason for Error	Comment/ Clearing Error Message
Brine Blocked	The brine draw rate of water to the brine tank was longer than normal.	Check brine line for blockages or air leaks. Check eductor and eductor screen for blockages
Brine Overfill	Too much water in brine tank. Plugged drain line flow control (Unit will not draw brine). Plugged eductor system (Unit will not draw brine). Slow leak to brine line. Faulty eductor piston. Power outage while control was in refill position.	Check eductor; check for brine draw. Clean drain line flow control. Clean eductor screen and nozzle Replace eductor piston
PROBLEM FOUND CALL CULLIGAN	This message is displayed if an error has been detected that requires servicing and no modem installed in the system.	Call the number shown. If possible, place this call using a phone that will allow you to see and enter changes to the main controller if required by the service technician during the call
Check Brine Tank	Aqua-Sensor did not detect brine during the regeneration cycle.	Check brine tank and add salt if necessary. Check Z ratio of the Aqua-Sensor at Main Menu/ Advanced / Diagnostics/ Check Sensors



Check SBT Sensor	SBT sensor indicated improper signals at the beginning of the refill cycle.	The SBT sensor may have an obstruction causing the optical detection paths to all be blocked at once; possible electrical open/short in SBT pcb or wire harness.
Low Battery	Battery needs replacement.	Replace with Panasonic Model# CR 2032 3V battery (see the electrical schematic/diagram in the unit's installation manual).
Low Salt Level	Salt level is low; less than 15 days of salt remaining.	Contact Culligan dealer for salt delivery or fill brine tank with salt.
Motor Home Err	The controller failed to detect proper position sensor feed back during INITIALIZATION (not during a regen or progressive flow)	Verify that the proper valve type was selected in First Time Setup. Check connections of motor and position sensors at both the motor and the GBE board.
No Brine In Tank	Failure to refill brine tank. Refill restrictor plugged. Air in brine line causes float to slam shut.	Clean or replace refill restrictor. Verify all tubing connections are properly assembled.
No Refill	Failure to refill brine tank. Refill restrictor plugged. Air in brine line cause float to slam shut.	Clean or replace refill restrictor. Verify all tubing connections are properly assembled.
No Remote Signal	Main board is not receiving a signal from the remote.	Remote is off, out of range or on a different channel from the main board. If interference is suspected, try moving the remote closer or switching to a different channel on both the main and remote units
Pos Sensor Err/ Motor Position Error	The controller is seeking a known valve position before/ during/after a regen, or during progressive flow, but cannot find it (this error does NOT appear during initialization).	Check connections of motor and position sensors at both the motor and GBE board.
Replace Ext Filt	Total gallons through the secondary filter (i.e. "Big Blue" filter) has exceeded the specified capacity of the Big Blue.	Replace optional filter cartridge. Reset the external filter media life at Main Menu/ Accessories/ Ext. Filter menu
Salt Bridging	Brine tank has low concentration of brine, but solid salt exists above the liquid brine level.	Use a tool to break up any salt bridge inside the brine tank



Sanitizing Procedure

A water softener in daily use on a potable water supply generally requires no special attention other than keeping the salt tank filled. Occasionally, however, a unit may require sanitization under one of the following conditions:

- At start-up time.
- After standing idle for a week or more.
- On private supplies, the appearance of off-tastes and odors, particularly if musty or “rotten egg” (caused by harmless sulfate-reducing bacteria).

NOTE: If the water supply contains iron, regenerate the softener before sanitizing to remove iron from the resin.



CAUTION! Caution! Hazard from toxic fumes! Chlorine bleach and common iron control chemicals may generate toxic fumes when mixed.

If the unit uses any compounds containing sodium hydrosulfite, sodium bisulfite, or any other reducing agent, disconnect the device feeding the chemical(s) and manually regenerate the unit before sanitizing.

Do not use this procedure if the softener salt contains iron control additives.

1. Remove the brine tank cover.
2. Pour directly into the brine chamber 1/3 to 1/2 cup of common household bleach (5.25% sodium hypochlorite) for each cubic foot of resin in the tank.
3. Manually start recharge. Allow the unit to complete the recharge cycle automatically.

If tastes and odors return frequently, even after sanitization, a continuous chlorination system may be needed. Send a water sample to a qualified laboratory for bacterial analysis.



When and How to Bypass Your Water Conditioner

Normally, all water except outside lines passes through the water softener. There are times when the water softener should be bypassed, using the Cul-Flo-Valv[®] Bypass, or a three-way bypass valve. You should bypass:

1. If lines to outside faucets do not bypass the water softener, and you do not want to waste softened water on lawn sprinkling or other outside uses.
2. If you are going away on vacation and do not want the unit to recharge.

Bypass Valve

In the back of Culligan water softener is a Cul-Flo-Valv[®] Bypass valve. To bypass the unit, turn the blue knob clockwise. To return to softened water service, turn the blue knob counter-clockwise.

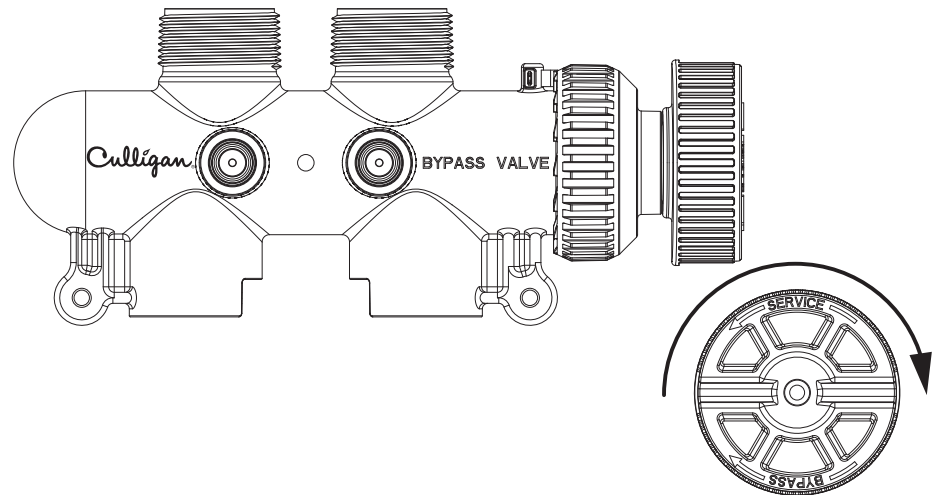

Figure 2. Bypass valve.

Bypassed

To BYPASS, turn the blue knob clockwise (see directional arrow on end of knob) until the knob stops as shown in Figure 1. DO NOT OVERTIGHTEN!

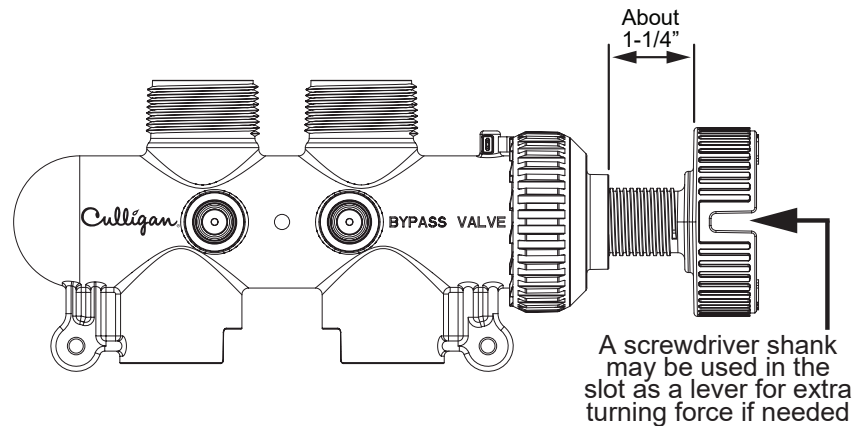

Figure 3. Service valve.

Softened Water

To return to SERVICE, turn the blue knob counter-clockwise (see directional arrow on end of knob) until the knob stops as shown in Figure 2. DO NOT OVERTIGHTEN!



Things to Check Before You Call for Service

If you unexpectedly experience changes in your water, make these simple checks before calling your Culligan dealer. One of the following conditions may be the reason for your interruption of service.

Important

If any of the following conditions is found, the water softener should be manually regenerated after you have corrected the problem. Refer to the Culligan HE Automatic Water Softener Owner's Guide, P/N 01021076.

Power Supply

Check your power supply cord. Is it plugged fully into the electric outlet? Be certain that the outlet is not controlled by a wall switch which has been turned off. Plug in the transformer then reset conditioner to the correct time of day.

Blown Fuse

Check the house fuse or circuit breaker panel. Replace a blown-out fuse or reset an open circuit breaker.

Power Failure

Any interruption in your power supply or time change—such as daylight savings—will disrupt your softener's regeneration schedule by causing the timer to run off-schedule. Reset the timer to the correct time of day.

Bypass Valves

Check to see if they are in the proper position. Cul-Flo-Valv® Bypass, if used, should be in the "Service" position (see [page 28](#)). If hand valves are used, see that inlet and outlet valve are opened and that the bypass valve is closed.

No Water

If you aren't getting any water flow at all, make sure your water supply is working. Open a tap ahead of the conditioner (outside tap) to see if you have any water pressure. If you have water pressure, check the bypass valve. If it is in the Service position, put it into the bypass and call your Culligan dealer for service.

Increased Usage

Guests, family additions, new water-using appliances, etc., will result in more water usage and will require more capacity from your softener. You can reprogram your regeneration schedule by following the directions in the Culligan HE Automatic Water Softener Owner's Guide, P/N 01021076. Call your Culligan dealer for advice and save a service call.



Navigating the Menus and Keypad

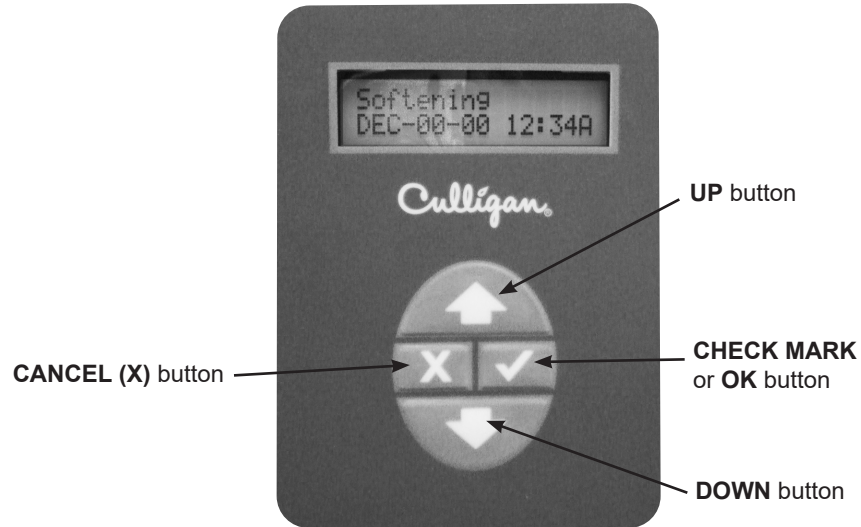

UP ARROW button: scrolls up the menu



DOWN ARROW button: scrolls down the menu



CHECK MARK button: selects the highlighted option, opens a new screen, or accepts a changed setting



CANCEL or **X** button: returns to the previous screen or cancels a changed setting

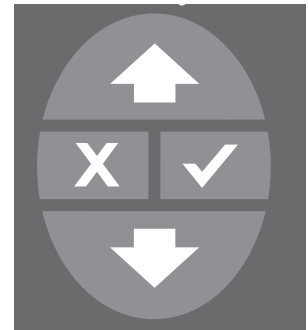

Controller



Remote

NOTE: Hold down  or  to quickly scroll through the setting without repeatedly pressing the button.

Softening
JAN-01-19 12:01P

1. This is the **HOME SCREEN**. Press any button except  to advance to the **MAIN MENU SCREEN**.

>1) INFORMATION
2) MANUAL MODE

2. This is the **MAIN MENU SCREEN**. The ">" symbol indicates the menu selection. Press  or  to scroll through the menu.



1) INFORMATION
>2) MANUAL MODE

3. This is the **MAIN MENU SCREEN**. The “>” symbol indicates the menu selection. Press or to scroll through the menu.
4. Press to select a setting.

MANUAL MODE
REGEN NOW

5. The screen displays the setting (Manual Mode) and the current value (Regen Now). Press to change the value.

MANUAL MODE
>REGEN NOW

6. The screen displays the “>” symbol next to the value, indicating that the value may be changed. Press or to change the value. For example, press to change the value to REGEN TONITE. Press again to select the next available value, BYPASS.

MANUAL MODE
REGEN NOW

7. Press to cancel the changed setting and revert to the default setting. The screen displays the default setting.

MANUAL MODE
>BYPASS

8. Press to accept the changed value. If the setting values are displayed, the “>” symbol no longer appears next to the value.

1) INFORMATION
>2) MANUAL MODE

9. The screen then returns to the **MAIN MENU**. Press to return to the HOME SCREEN.

Softening
JAN-01-19 12:01P

10. The screen displays the **HOME SCREEN**.

NOTE: Unplugging the Culligan HE water softener will not affect any of the control settings (the control must be plugged in for at least 10 minutes). Once programmed, the settings will be stored indefinitely.



Performance Data Sheet

Culligan HE 9" Softener-Clear Water Conditioner

Culligan knows the more informed you are about your water treatment systems, the more confident you will be about its performance. It's because of this and more than seventy years of commitment to customer satisfaction that Culligan is providing this Performance Data Sheet to its customers.

NOTICE Read this Performance Data Sheet and compare the capabilities of this unit with your actual water treatment needs. It is recommended that before purchasing a water treatment unit, you have your water supply tested to determine your actual water treatment needs.

Manufacturer: Culligan International Company
 9399 W. Higgins Rd., Suite 1100, Rosemont, IL 60018 USA
 (847) 430-2800
www.culligan.com

Product: Culligan High Efficiency 9" Softener-Clear Water Conditioner

The Culligan High Efficiency 9" Softener-Clear Water Conditioners are tested and certified by WQA against CSA B483.1, NSF/ANSI/CAN Standard 61, NSF/ANSI Standard 372 for the low lead compliance, NSF/ANSI Standard 44 for the effective reduction of hardness (calcium and magnesium), and NSF/ANSI 42 for the effective iron reduction up to 10ppm, as verified and substantiated by test data.



Testing Conditions and Results

Flow Rate:	9.0 gpm @ 12 psi	Capacity:	17,854 grains @ 4.0 lb. salt
Pressure:	30–40 psi (2.1–2.8 kg/cm ²)		27,108 grains @ 8.0 lb. salt
Acidity:	Non-Corrosive		31,736 grains @ 12.0 lb. salt
Temperature:	68°F (20°C)	pH:	7.6
Efficiency Rated Dosage†:	4,463 gr/lb		

Softener Specifications

Service Flow Rate: 9.0 gpm	Max. Drain Flow Rate: 2.38 gpm
Operating Temp. Range: 33–120°F (0–49°C)	Pressure Drop at Max. Flow Rate: 12 psi
Working Press. Range: 20–125 psi (1.41–8.79 kg/cm ²)	Oper. Press. Range (Canada): 20–90 psi (1.41–6.33 kg/cm ²)

Name of Substance	USEPA Max. Contaminant Level	pH	Flow Rate	Pressure
Barium	2.0 mg/L	7.5 + 0.5	9.0 gpm	12 (psig)
Radium 226/228	5 pCi/L	7.5 + 0.5	9.0 gpm	12 (psig)

This system is certified for barium and radium 226/228 reduction based on hardness reduction. It is recommended you test your water every six months to ensure the system is performing properly and that hardness, and therefore barium and radium 226/228, are being reduced. Hardness test strips have been included. Additional strips are available from your local Culligan dealer.

An efficiency rated water softener is a DIR softener which also complies with specific performance specifications intended to minimize the amount of regenerant brine and water used in its operation. Efficiency rated water softeners shall have a rated salt efficiency of not less than 3350 grains of total hardness exchange per pound of salt (based on NaCl equivalency) (477 grams of total hardness exchange per kilogram of salt), and shall not deliver more salt than its listed rating. The efficiency is measured by a laboratory test described in NSF/ANSI 44. The test represents the maximum possible efficiency the system can achieve. Operational efficiency is the actual efficiency achieved after the system has been installed. It is typically less than the efficiency due to individual application factors including water hardness, water usage, and other contaminants that reduce the softener's capacity.

Dissolved Iron Reduction Testing Conditions and Results:

The Culligan High Efficiency 9" Softener-Clear Water Conditioner has been tested according to NSF/ANSI standard 42 for effective reduction of iron up to 2,000 gallons with influent dissolved iron level up to 10 ppm. The concentration of the indicated substances in water entering the system was reduced to a concentration less than or equal to the permissible limit for water leaving the system, as specified in NSF/ANSI 42.

Substance	Influent Challenge Concentration	Max Permissible Product Water Concentration	Flow Rate
Iron	10 mg/L	0.3 mg/L	9.0 gpm

Refer to the Specifications, Familiarization and Warranty section of this Owner's Guide for more specific product information. To avoid contamination from improper handling and installation, your system should only be installed and serviced by your Culligan Man. Performance will vary based on local water conditions. The substances reduced by this system are not necessarily in your water.

Culligan water softeners are designed to work with any salt of good quality, although it is recommended that you ask your local Culligan service technician to suggest the best type and grade of salt to use in this softener.

NOTICE This softener is not intended to be used for treating water that is microbiologically unsafe or of unknown quality without adequate disinfection before or after the system.

†The efficiency rated dosage is only valid at the 4 lb. salt dosage and maximum service flow rate for 9" models.



Performance Data Sheet

Culligan HE 10" Softener-Clear Water Conditioner

Culligan knows the more informed you are about your water treatment systems, the more confident you will be about its performance. It's because of this and more than seventy years of commitment to customer satisfaction that Culligan is providing this Performance Data Sheet to its customers.

NOTICE Read this Performance Data Sheet and compare the capabilities of this unit with your actual water treatment needs. It is recommended that before purchasing a water treatment unit, you have your water supply tested to determine your actual water treatment needs.

Manufacturer: Culligan International Company
 9399 W. Higgins Rd., Suite 1100, Rosemont, IL 60018 USA
 (847) 430-2800
www.culligan.com

Product: Culligan High Efficiency 10" Softener-Clear Water Conditioner

The Culligan High Efficiency 10" Softener-Clear Water Conditioners are tested and certified by WQA against CSA B483.1, NSF/ANSI/CAN Standard 61, NSF/ANSI Standard 372 for the low lead compliance, NSF/ANSI Standard 44 for the effective reduction of hardness (calcium and magnesium), and NSF/ANSI 42 for the effective iron reduction up to 10ppm, as verified and substantiated by test data.



Testing Conditions and Results

Flow Rate:	9.4 gpm @ 13 psi	Capacity: 26,781 grains @ 6.0 lb. salt
Pressure:	30–40 psi (2.1–2.8 kg/cm ²)	40,662 grains @ 12.0 lb. salt
Acidity:	Non-Corrosive	47,604 grains @ 18.0 lb. salt
Temperature:	68°F (20°C)	pH: 7.6
Efficiency Rated Dosage†:	4,463 gr/lb	

Softener Specifications

Service Flow Rate: 9.4 gpm	Max. Drain Flow Rate: 2.0 gpm
Operating Temp. Range: 33–120°F (0–49°C)	Pressure Drop at Max. Flow Rate: 13 psi
Working Press. Range: 20–125 psi (1.41–8.79 kg/cm ²)	Oper. Press. Range (Canada): 20–90 psi (1.41–6.33 kg/cm ²)

Name of Substance	USEPA Max. Contaminant Level	pH	Flow Rate	Pressure
Barium	2.0 mg/L	7.5 + 0.5	9.4 gpm	13 (psig)
Radium 226/228	5 pCi/L	7.5 + 0.5	9.4 gpm	13 (psig)

This system is certified for barium and radium 226/228 reduction based on hardness reduction. It is recommended you test your water every six months to ensure the system is performing properly and that hardness, and therefore barium and radium 226/228, are being reduced. Hardness test strips have been included. Additional strips are available from your local Culligan dealer.

An efficiency rated water softener is a DIR softener which also complies with specific performance specifications intended to minimize the amount of regenerant brine and water used in its operation. Efficiency rated water softeners shall have a rated salt efficiency of not less than 3350 grains of total hardness exchange per pound of salt (based on NaCl equivalency) (477 grams of total hardness exchange per kilogram of salt), and shall not deliver more salt than its listed rating. The efficiency is measured by a laboratory test described in NSF/ANSI 44. The test represents the maximum possible efficiency the system can achieve. Operational efficiency is the actual efficiency achieved after the system has been installed. It is typically less than the efficiency due to individual application factors including water hardness, water usage, and other contaminants that reduce the softener's capacity.

Dissolved Iron Reduction Testing Conditions and Results:

The Culligan High Efficiency 10" Softener-Clear Water Conditioner has been tested according to NSF/ANSI standard 42 for effective reduction of iron up to 3,000 gallons with influent dissolved iron level up to 10 ppm. The concentration of the indicated substances in water entering the system was reduced to a concentration less than or equal to the permissible limit for water leaving the system, as specified in NSF/ANSI 42.

Substance	Influent Challenge Concentration	Max Permissible Product Water Concentration	Flow Rate
Iron	10 mg/L	0.3 mg/L	9.4 gpm

Refer to the Specifications, Familiarization and Warranty section of this Owner's Guide for more specific product information. To avoid contamination from improper handling and installation, your system should only be installed and serviced by your Culligan Man. Performance will vary based on local water conditions. The substances reduced by this system are not necessarily in your water.

Culligan water softeners are designed to work with any salt of good quality, although it is recommended that you ask your local Culligan service technician to suggest the best type and grade of salt to use in this softener.

NOTICE This softener is not intended to be used for treating water that is microbiologically unsafe or of unknown quality without adequate disinfection before or after the system.

†The efficiency rated dosage is only valid at the 6 lb. salt dosage and maximum service flow rate for 10" models.



Performance Data Sheet

Culligan HE 12" Softener-Clear Water Conditioner

Culligan knows the more informed you are about your water treatment systems, the more confident you will be about its performance. It's because of this and more than seventy years of commitment to customer satisfaction that Culligan is providing this Performance Data Sheet to its customers.

NOTICE Read this Performance Data Sheet and compare the capabilities of this unit with your actual water treatment needs. It is recommended that before purchasing a water treatment unit, you have your water supply tested to determine your actual water treatment needs.

Manufacturer: Culligan International Company
 9399 W. Higgins Rd., Suite 1100, Rosemont, IL 60018 USA
 (847) 430-2800
www.culligan.com

Product: Culligan High Efficiency 12" Softener-Clear Water Conditioner

The Culligan High Efficiency 12" Softener-Clear Water Conditioners are tested and certified by WQA against CSA B483.1, NSF/ANSI/CAN Standard 61, NSF/ANSI Standard 372 for the low lead compliance, NSF/ANSI Standard 44 for the effective reduction of hardness (calcium and magnesium), and NSF/ANSI 42 for the effective iron reduction up to 10ppm, as verified and substantiated by test data.



Testing Conditions and Results

Flow Rate:	10.0 gpm @ 11 psi	Capacity:	31,352 grains @ 7.0 lb. salt
Pressure:	30–40 psi (2.1–2.8 kg/cm ²)		48,458 grains @ 16.0 lb. salt
Acidity:	Non-Corrosive		59,267 grains @ 24.0 lb. salt
Temperature:	68°F (20°C)	pH:	7.6
Efficiency Rated Dosage†:	4,479 gr/lb		

Softener Specifications

Service Flow Rate:	10.0 gpm	Max. Drain Flow Rate:	3.5 gpm
Operating Temp. Range:	33–120°F (0–49°C)	Pressure Drop at Max. Flow Rate:	11 psi
Working Press. Range:	20–125 psi (1.41–8.79 kg/cm ²)	Oper. Press. Range (Canada):	20–90 psi (1.41–6.33 kg/cm ²)

Name of Substance	USEPA Max. Contaminant Level	pH	Flow Rate	Pressure
Barium	2.0 mg/L	7.5 + 0.5	10.0 gpm	11 (psig)
Radium 226/228	5 pCi/L	7.5 + 0.5	10.0 gpm	11 (psig)

This system is certified for barium and radium 226/228 reduction based on hardness reduction. It is recommended you test your water every six months to ensure the system is performing properly and that hardness, and therefore barium and radium 226/228, are being reduced. Hardness test strips have been included. Additional strips are available from your local Culligan dealer.

An efficiency rated water softener is a DIR softener which also complies with specific performance specifications intended to minimize the amount of regenerant brine and water used in its operation. Efficiency rated water softeners shall have a rated salt efficiency of not less than 3350 grains of total hardness exchange per pound of salt (based on NaCl equivalency) (477 grams of total hardness exchange per kilogram of salt), and shall not deliver more salt than its listed rating. The efficiency is measured by a laboratory test described in NSF/ANSI 44. The test represents the maximum possible efficiency the system can achieve. Operational efficiency is the actual efficiency achieved after the system has been installed. It is typically less than the efficiency due to individual application factors including water hardness, water usage, and other contaminants that reduce the softener's capacity.

Dissolved Iron Reduction Testing Conditions and Results:

The Culligan High Efficiency 12" Softener-Clear Water Conditioner has been tested according to NSF/ANSI standard 42 for effective reduction of iron up to 4,000 gallons with influent dissolved iron level up to 10 ppm. The concentration of the indicated substances in water entering the system was reduced to a concentration less than or equal to the permissible limit for water leaving the system, as specified in NSF/ANSI 42.

Substance	Influent Challenge Concentration	Max Permissible Product Water Concentration	Flow Rate
Iron	10 mg/L	0.3 mg/L	10.0 gpm

Refer to the Specifications, Familiarization and Warranty section of this Owner's Guide for more specific product information. To avoid contamination from improper handling and installation, your system should only be installed and serviced by your Culligan Man. Performance will vary based on local water conditions. The substances reduced by this system are not necessarily in your water.

Culligan water softeners are designed to work with any salt of good quality, although it is recommended that you ask your local Culligan service technician to suggest the best type and grade of salt to use in this softener.

NOTICE This softener is not intended to be used for treating water that is microbiologically unsafe or of unknown quality without adequate disinfection before or after the system.

†The efficiency rated dosage is only valid at the 7 lb. salt dosage and maximum service flow rate for 12" models.



Performance Data Sheet

Culligan HE 14" Softener-Clear Water Conditioner

Culligan knows the more informed you are about your water treatment systems, the more confident you will be about its performance. It's because of this and more than seventy years of commitment to customer satisfaction that Culligan is providing this Performance Data Sheet to its customers.

NOTICE Read this Performance Data Sheet and compare the capabilities of this unit with your actual water treatment needs. It is recommended that before purchasing a water treatment unit, you have your water supply tested to determine your actual water treatment needs.

Manufacturer: Culligan International Company
 9399 W. Higgins Rd., Suite 1100, Rosemont, IL 60018 USA
 (847) 430-2800
www.culligan.com

Product: Culligan High Efficiency 14" Softener-Clear Water Conditioner

The Culligan High Efficiency 14" Softener-Clear Water Conditioners are tested and certified by WQA against CSA B483.1, NSF/ANSI/CAN Standard 61, NSF/ANSI Standard 372 for the low lead compliance, NSF/ANSI Standard 44 for the effective reduction of hardness (calcium and magnesium), and NSF/ANSI 42 for the effective iron reduction up to 10ppm, as verified and substantiated by test data.



Testing Conditions and Results

Flow Rate:	10.6 gpm @ 11 psi	Capacity:	42,548 grains @ 10.5 lb. salt
Pressure:	30–40 psi (2.1–2.8 kg/cm ²)		67,146 grains @ 24.0 lb. salt
Acidity:	Non-Corrosive		87,987 grains @ 36.0 lb. salt
Temperature:	68°F (20°C)	pH:	7.6
Efficiency Rated Dosage†:	4,052 gr/lb @ 10.5 lb. salt		

Softener Specifications

Service Flow Rate:	10.6 gpm	Max. Drain Flow Rate:	5.3 gpm
Operating Temp. Range:	33-120°F (0–49°C)	Pressure Drop at Max. Flow Rate:	11 psi
Working Press. Range:	20-125 psi (1.41–8.79 kg/cm ²)	Oper. Press. Range (Canada):	20-90 psi (1.41–6.33 kg/cm ²)

Name of Substance	USEPA Max. Contaminant Level	pH	Flow Rate	Pressure
Barium	2.0 mg/L	7.5 + 0.5	10.6 gpm	11 (psig)
Radium 226/228	5 pCi/L	7.5 + 0.5	10.6 gpm	11 (psig)

This system is certified for barium and radium 226/228 reduction based on hardness reduction. It is recommended you test your water every six months to ensure the system is performing properly and that hardness, and therefore barium and radium 226/228, are being reduced. Hardness test strips have been included. Additional strips are available from your local Culligan dealer.

An efficiency rated water softener is a DIR softener which also complies with specific performance specifications intended to minimize the amount of regenerant brine and water used in its operation. Efficiency rated water softeners shall have a rated salt efficiency of not less than 3350 grains of total hardness exchange per pound of salt (based on NaCl equivalency) (477 grams of total hardness exchange per kilogram of salt), and shall not deliver more salt than its listed rating. The efficiency is measured by a laboratory test described in NSF/ANSI 44. The test represents the maximum possible efficiency the system can achieve. Operational efficiency is the actual efficiency achieved after the system has been installed. It is typically less than the efficiency due to individual application factors including water hardness, water usage, and other contaminants that reduce the softener's capacity.

Dissolved Iron Reduction Testing Conditions and Results:

The Culligan High Efficiency 14" Softener-Clear Water Conditioner has been tested according to NSF/ANSI standard 42 for effective reduction of iron up to 6,000 gallons with influent dissolved iron level up to 10 ppm. The concentration of the indicated substances in water entering the system was reduced to a concentration less than or equal to the permissible limit for water leaving the system, as specified in NSF/ANSI 42.

Substance	Influent Challenge Concentration	Max Permissible Product Water Concentration	Flow Rate
Iron	10 mg/L	0.3 mg/L	10.6 gpm

Refer to the Specifications, Familiarization and Warranty section of this Owner's Guide for more specific product information. To avoid contamination from improper handling and installation, your system should only be installed and serviced by your Culligan Man. Performance will vary based on local water conditions. The substances reduced by this system are not necessarily in your water.

Culligan water softeners are designed to work with any salt of good quality, although it is recommended that you ask your local Culligan service technician to suggest the best type and grade of salt to use in this softener.

NOTICE This softener is not intended to be used for treating water that is microbiologically unsafe or of unknown quality without adequate disinfection before or after the system.

†The efficiency rated dosage is only valid at the 12 lb. salt dosage and maximum service flow rate for 14" models.



Performance Data Sheet

Culligan HE 9" Softener-Clear Plus Water Conditioner

Culligan knows the more informed you are about your water treatment systems, the more confident you will be about its performance. It's because of this and more than seventy years of commitment to customer satisfaction that Culligan is providing this Performance Data Sheet to its customers.

NOTICE Read this Performance Data Sheet and compare the capabilities of this unit with your actual water treatment needs. It is recommended that before purchasing a water treatment unit, you have your water supply tested to determine your actual water treatment needs.

Manufacturer: Culligan International Company
 9399 W. Higgins Rd., Suite 1100, Rosemont, IL 60018 USA
 (847) 430-2800
www.culligan.com

Product: Culligan High Efficiency 9" Softener-Clear Plus Water Conditioner

The Culligan High Efficiency 9" Softener-Clear Plus Water Conditioners are tested and certified by WQA against CSA B483.1, NSF/ANSI/CAN Standard 61, NSF/ANSI Standard 372 for the low lead compliance, NSF/ANSI Standard 44 for the effective reduction of hardness (calcium and magnesium), and NSF/ANSI 42 for the effective iron reduction up to 10ppm, as verified and substantiated by test data.



Testing Conditions and Results

Flow Rate:	8.0 gpm @ 9.5 psi	Capacity:	17,854 grains @ 4.0 lb. salt
Pressure:	30–40 psi (2.1–2.8 kg/cm ²)		27,108 grains @ 8.0 lb. salt
Acidity:	Non-Corrosive		31,736 grains @ 12.0 lb. salt
Temperature:	68°F (20°C)	pH:	7.6
Efficiency Rated Dosage†:	4,463 gr/lb		

Softener Specifications

Service Flow Rate: 8.0 gpm	Max. Drain Flow Rate: 2.34 gpm
Operating Temp. Range: 33–120°F (0–49°C)	Pressure Drop at Max. Flow Rate: 9.5 psi
Working Press. Range: 20–125 psi (1.41–8.79 kg/cm ²)	Oper. Press. Range (Canada): 20–90 psi (1.41–6.33 kg/cm ²)

Name of Substance	USEPA Max. Contaminant Level	pH	Flow Rate	Pressure
Barium	2.0 mg/L	7.5 + 0.5	8.0 gpm	9.5 (psig)
Radium 226/228	5 pCi/L	7.5 + 0.5	8.0 gpm	9.5 (psig)

This system is certified for barium and radium 226/228 reduction based on hardness reduction. It is recommended you test your water every six months to ensure the system is performing properly and that hardness, and therefore barium and radium 226/228, are being reduced. Hardness test strips have been included. Additional strips are available from your local Culligan dealer.

An efficiency rated water softener is a DIR softener which also complies with specific performance specifications intended to minimize the amount of regenerant brine and water used in its operation. Efficiency rated water softeners shall have a rated salt efficiency of not less than 3350 grains of total hardness exchange per pound of salt (based on NaCl equivalency) (477 grams of total hardness exchange per kilogram of salt), and shall not deliver more salt than its listed rating. The efficiency is measured by a laboratory test described in NSF/ANSI 44. The test represents the maximum possible efficiency the system can achieve. Operational efficiency is the actual efficiency achieved after the system has been installed. It is typically less than the efficiency due to individual application factors including water hardness, water usage, and other contaminants that reduce the softener's capacity.

Dissolved Iron Reduction Testing Conditions and Results:

The Culligan High Efficiency 9" Softener-Clear Plus Water Conditioner has been tested according to NSF/ANSI standard 42 for effective reduction of iron up to 2,000 gallons with influent dissolved iron level up to 10 ppm. The claim is only valid for flow rate restricted to 4gpm. The concentration of the indicated substances in water entering the system was reduced to a concentration less than or equal to the permissible limit for water leaving the system, as specified in NSF/ANSI 42.

Substance	Influent Challenge Concentration	Max Permissible Product Water Concentration	Flow Rate
Iron	10 mg/L	0.3 mg/L	4.0 gpm

Refer to the Specifications, Familiarization and Warranty section of this Owner's Guide for more specific product information. To avoid contamination from improper handling and installation, your system should only be installed and serviced by your Culligan Man. Performance will vary based on local water conditions. The substances reduced by this system are not necessarily in your water.

Culligan water softeners are designed to work with any salt of good quality, although it is recommended that you ask your local Culligan service technician to suggest the best type and grade of salt to use in this softener.

NOTICE This conditioner is not intended to be used for treating water that is microbiologically unsafe or of unknown quality without adequate disinfection before or after the system.

†The efficiency rated dosage is only valid at the 4 lb. salt dosage and maximum service flow rate for 9" models.



Performance Data Sheet

Culligan HE 10" Softener-Clear Plus Water Conditioner

Culligan knows the more informed you are about your water treatment systems, the more confident you will be about its performance. It's because of this and more than seventy years of commitment to customer satisfaction that Culligan is providing this Performance Data Sheet to its customers.

NOTICE Read this Performance Data Sheet and compare the capabilities of this unit with your actual water treatment needs. It is recommended that before purchasing a water treatment unit, you have your water supply tested to determine your actual water treatment needs.

Manufacturer: Culligan International Company
9399 W. Higgins Rd., Suite 1100, Rosemont, IL 60018 USA
(847) 430-2800

Product: Culligan High Efficiency 10" Softener-Clear Plus Water Conditioner

The Culligan High Efficiency 10" Softener-Clear Plus Water Conditioners are tested and certified by WQA against CSA B483.1, NSF/ANSI/CAN Standard 61, NSF/ANSI Standard 372 for the low lead compliance, NSF/ANSI Standard 44 for the effective reduction of hardness (calcium and magnesium), and NSF/ANSI 42 for the effective iron reduction up to 10ppm, as verified and substantiated by test data.



Testing Conditions and Results

Flow Rate:	9.9 gpm @ 14 psi	Capacity: 26,781 grains @ 6.0 lb. salt
Pressure:	30–40 psi (2.1–2.8 kg/cm ²)	40,662 grains @ 12.0 lb. salt
Acidity:	Non-Corrosive	47,604 grains @ 18.0 lb. salt
Temperature:	68°F (20°C)	pH: 7.6
Efficiency Rated Dosage†:	4,463 gr/lb	

Softener Specifications

Service Flow Rate: 9.9 gpm	Max. Drain Flow Rate: 2.5 gpm
Operating Temp. Range: 33-120°F (0–49°C)	Pressure Drop at Max. Flow Rate: 14 psi
Working Press. Range: 20-125 psi (1.41–8.79 kg/cm ²)	Oper. Press. Range (Canada): 20-90 psi (1.41–6.33 kg/cm ²)

Name of Substance	USEPA Max. Contaminant Level	pH	Flow Rate	Pressure
Barium	2.0 mg/L	7.5 + 0.5	9.9 gpm	14 (psig)
Radium 226/228	5 pCi/L	7.5 + 0.5	9.9 gpm	14 (psig)

This system is certified for barium and radium 226/228 reduction based on hardness reduction. It is recommended you test your water every six months to ensure the system is performing properly and that hardness, and therefore barium and radium 226/228, are being reduced. Hardness test strips have been included. Additional strips are available from your local Culligan dealer.

An efficiency rated water softener is a DIR softener which also complies with specific performance specifications intended to minimize the amount of regenerant brine and water used in its operation. Efficiency rated water softeners shall have

A rated salt efficiency of not less than 3350 grains of total hardness exchange per pound of salt (based on NaCl equivalency) (477 grams of total hardness exchange per kilogram of salt), and shall not deliver more salt than its listed rating. The efficiency is measured by a laboratory test described in NSF/ANSI 44. The test represents the maximum possible efficiency the system can achieve. Operational efficiency is the actual efficiency achieved after the system has been installed. It is typically less than the efficiency due to individual application factors including water hardness, water usage, and other contaminants that reduce the softener's capacity.

Dissolved Iron Reduction Testing Conditions and Results:

The Culligan High Efficiency 10" Softener-Clear Plus Water Conditioner has been tested according to NSF/ANSI standard 42 for effective reduction of iron up to 3,000 gallons with influent dissolved iron level up to 10 ppm. The claim is only valid for flow rate restricted to 5.9 gpm. The concentration of the indicated substances in water entering the system was reduced to a concentration less than or equal to the permissible limit for water leaving the system, as specified in NSF/ANSI 42.

Substance	Influent Challenge Concentration	Max Permissible Product Water Concentration	Flow Rate
Iron	10 mg/L	0.3 mg/L	5.9 gpm

Refer to the Specifications, Familiarization and Warranty section of this Owner's Guide for more specific product information. To avoid contamination from improper handling and installation, your system should only be installed and serviced by your Culligan Man. Performance will vary based on local water conditions. The substances reduced by this system are not necessarily in your water.

Culligan water softeners are designed to work with any salt of good quality, although it is recommended that you ask your local Culligan service technician to suggest the best type and grade of salt to use in this softener.

NOTICE This conditioner is not intended to be used for treating water that is microbiologically unsafe or of unknown quality without adequate disinfection before or after the system.

†The efficiency rated dosage is only valid at the 6 lb. salt dosage and maximum service flow rate for 10" models.



Performance Data Sheet

Culligan HE 12" Softener-Clear Plus Water Conditioner

Culligan knows the more informed you are about your water treatment systems, the more confident you will be about its performance. It's because of this and more than seventy years of commitment to customer satisfaction that Culligan is providing this Performance Data Sheet to its customers.

NOTICE Read this Performance Data Sheet and compare the capabilities of this unit with your actual water treatment needs. It is recommended that before purchasing a water treatment unit, you have your water supply tested to determine your actual water treatment needs.

Manufacturer: Culligan International Company
 9399 W. Higgins Rd., Suite 1100, Rosemont, IL 60018 USA
 (847) 430-2800
www.culligan.com

Product: Culligan High Efficiency 12" Softener-Clear Plus Water Conditioner

The Culligan High Efficiency 12" Softener-Clear Plus Water Conditioners are tested and certified by WQA against CSA B483.1, NSF/ANSI/CAN Standard 61, NSF/ANSI Standard 372 for the low lead compliance, NSF/ANSI Standard 44 for the effective reduction of hardness (calcium and magnesium), and NSF/ANSI 42 for the effective iron reduction up to 10ppm, as verified and substantiated by test data.



Testing Conditions and Results

Flow Rate:	8.5 gpm @ 9 psi	Capacity:	31,200 grains @ 7.0 lb. salt
Pressure:	30–40 psi (2.1–2.8 kg/cm ²)		44,764 grains @ 16.0 lb. salt
Acidity:	Non-Corrosive		63,472 grains @ 24.0 lb. salt
Temperature:	68°F (20°C)	pH:	7.6
Efficiency Rated Dosage†:	4,457 gr/lb		

Softener Specifications

Service Flow Rate: 8.5 gpm	Max. Drain Flow Rate: 3.5 gpm
Operating Temp. Range: 33-120°F (0–49°C)	Pressure Drop at Max. Flow Rate: 9 psi
Working Press. Range: 20-125 psi (1.41–8.79 kg/cm ²)	Oper. Press. Range (Canada): 20-90 psi (1.41–6.33 kg/cm ²)

Name of Substance	USEPA Max. Contaminant Level	pH	Flow Rate	Pressure
Barium	2.0 mg/L	7.5 + 0.5	8.5 gpm	9 (psig)
Radium 226/228	5 pCi/L	7.5 + 0.5	8.5 gpm	9 (psig)

This system is certified for barium and radium 226/228 reduction based on hardness reduction. It is recommended you test your water every six months to ensure the system is performing properly and that hardness, and therefore barium and radium 226/228, are being reduced. Hardness test strips have been included. Additional strips are available from your local Culligan dealer.

An efficiency rated water softener is a DIR softener which also complies with specific performance specifications intended to minimize the amount of regenerant brine and water used in its operation. Efficiency rated water softeners shall have

A rated salt efficiency of not less than 3350 grains of total hardness exchange per pound of salt (based on NaCl equivalency) (477 grams of total hardness exchange per kilogram of salt), and shall not deliver more salt than its listed rating. The efficiency is measured by a laboratory test described in NSF/ANSI 44. The test represents the maximum possible efficiency the system can achieve.

Operational efficiency is the actual efficiency achieved after the system has been installed. It is typically less than the efficiency due to individual application factors including water hardness, water usage, and other contaminants that reduce the softener's capacity.

Dissolved Iron Reduction Testing Conditions and Results:

The Culligan High Efficiency 12" Softener-Clear Plus Water Conditioner has been tested according to NSF/ANSI standard 42 for effective reduction of iron up to 4,000 gallons with influent dissolved iron level up to 10 ppm. The claim is only valid for flow rate restricted to 8.5 gpm. The concentration of the indicated substances in water entering the system was reduced to a concentration less than or equal to the permissible limit for water leaving the system, as specified in NSF/ANSI 42.

Substance	Influent Challenge Concentration	Max Permissible Product Water Concentration	Flow Rate
Iron	10 mg/L	0.3 mg/L	8.5 gpm

Refer to the Specifications, Familiarization and Warranty section of this Owner's Guide for more specific product information. To avoid contamination from improper handling and installation, your system should only be installed and serviced by your Culligan Man. Performance will vary based on local water conditions. The substances reduced by this system are not necessarily in your water.

Culligan water softeners are designed to work with any salt of good quality, although it is recommended that you ask your local Culligan service technician to suggest the best type and grade of salt to use in this softener.

NOTICE This conditioner is not intended to be used for treating water that is microbiologically unsafe or of unknown quality without adequate disinfection before or after the system.

†The efficiency rated dosage is only valid at the 7 lb. salt dosage and maximum service flow rate for 12" models.



Performance Data Sheet

Culligan HE 14" Softener-Clear Plus Water Conditioner

Culligan knows the more informed you are about your water treatment systems, the more confident you will be about its performance. It's because of this and more than seventy years of commitment to customer satisfaction that Culligan is providing this Performance Data Sheet to its customers.

NOTICE Read this Performance Data Sheet and compare the capabilities of this unit with your actual water treatment needs. It is recommended that before purchasing a water treatment unit, you have your water supply tested to determine your actual water treatment needs.

Manufacturer: Culligan International Company
 9399 W. Higgins Rd., Suite 1100, Rosemont, IL 60018 USA
 (847) 430-2800
www.culligan.com

Product: Culligan High Efficiency 14" Softener-Clear Plus Water Conditioner

The Culligan High Efficiency 14" Softener-Clear Plus Water Conditioners are tested and certified by WQA against CSA B483.1, NSF/ANSI/CAN Standard 61, NSF/ANSI Standard 372 for the low lead compliance, NSF/ANSI Standard 44 for the effective reduction of hardness (calcium and magnesium), and NSF/ANSI 42 for the effective iron reduction up to 10ppm, as verified and substantiated by test data.



Testing Conditions and Results

Flow Rate:	11.0 gpm @ 15 psi	Capacity:	42,548 grains @ 10.5 lb. salt
Pressure:	30–40 psi (2.1–2.8 kg/cm ²)		67,146 grains @ 24.0 lb. salt
Acidity:	Non-Corrosive		87,987 grains @ 36.0 lb. salt
Temperature:	68°F (20°C)	pH:	7.6
Efficiency Rated Dosage†:	4,052 gr/lb @ 10.5 lb. salt		

Softener Specifications

Service Flow Rate:	11.0 gpm	Max. Drain Flow Rate:	5.3 gpm
Operating Temp. Range:	33-120°F (0–49°C)	Pressure Drop at Max. Flow Rate:	15 psi
Working Press. Range:	20-125 psi (1.41–8.79 kg/cm ²)	Oper. Press. Range (Canada):	20-90 psi (1.41–6.33 kg/cm ²)

Name of Substance	USEPA Max. Contaminant Level	pH	Flow Rate	Pressure
Barium	2.0 mg/L	7.5 + 0.5	11.0 gpm	15 (psig)
Radium 226/228	5 pCi/L	7.5 + 0.5	11.0 gpm	15 (psig)

This system is certified for barium and radium 226/228 reduction based on hardness reduction. It is recommended you test your water every six months to ensure the system is performing properly and that hardness, and therefore barium and radium 226/228, are being reduced. Hardness test strips have been included. Additional strips are available from your local Culligan dealer.

An efficiency rated water softener is a DIR softener which also complies with specific performance specifications intended to minimize the amount of regenerated brine and water used in its operation. Efficiency rated water softeners shall have a rated salt efficiency of not less than 3350 grains of total hardness exchange per pound of salt (based on NaCl equivalency) (477 grams of total hardness exchange per kilogram of salt), and shall not deliver more salt than its listed rating. The efficiency is measured by a laboratory test described in NSF/ANSI 44. The test represents the maximum possible efficiency the system can achieve. Operational efficiency is the actual efficiency achieved after the system has been installed. It is typically less than the efficiency due to individual application factors including water hardness, water usage, and other contaminants that reduce the softener's capacity.

Dissolved Iron Reduction Testing Conditions and Results:

Culligan High Efficiency 14" Softener-Clear Plus Water Conditioner has been tested according to NSF/ANSI standard 42 for effective reduction of iron up to 6,000 gallons with influent dissolved iron level up to 10 ppm. The claim is only valid for flow rate restricted to 11.6 gpm. The concentration of the indicated substances in water entering the system was reduced to a concentration less than or equal to the permissible limit for water leaving the system, as specified in NSF/ANSI 42.

Substance	Influent Challenge Concentration	Max Permissible Product Water Concentration	Flow Rate
Iron	10 mg/L	0.3 mg/L	11.6 gpm

Refer to the Specifications, Familiarization and Warranty section of this Owner's Guide for more specific product information. To avoid contamination from improper handling and installation, your system should only be installed and serviced by your Culligan Man. Performance will vary based on local water conditions. The substances reduced by this system are not necessarily in your water.

Culligan water softeners are designed to work with any salt of good quality, although it is recommended that you ask your local Culligan service technician to suggest the best type and grade of salt to use in this softener.

NOTICE This conditioner is not intended to be used for treating water that is microbiologically unsafe or of unknown quality without adequate disinfection before or after the system.

†The efficiency rated dosage is only valid at the 12 lb. salt dosage and maximum service flow rate for 14" models.



**Culligan
Limited
Warranty**

Culligan Softener-Cleer Automatic Water Conditioners

You have just purchased one of the finest water conditioners made. As an expression of our confidence in Culligan International Company products, your water conditioner is warranted to the original end user, when installed in accordance with Culligan specifications, against defects in material and workmanship from the date of original installation, as follows:

For a period of ONE YEAR	The entire conditioner and Culligan Softener-Cleer Media
For a period of FIVE YEARS	Remote display, modem, Soft-Minder® meter, or Smart Brine probe, if so equipped.
For a period of TEN YEARS	High Efficiency circuit board, control valve body, excluding internal parts. The salt storage container, brine valve and all its component parts
For the LIFETIME of the original consumer purchaser	The Quadra-Hull™ conditioner tank and the Cullex® resin

If a part described above is found defective within the specified period, you should notify your independently operated Culligan dealer and arrange a time during normal business hours for the dealer to inspect the water conditioner on your premises. Any part found defective within the terms of this warranty will be repaired or replaced by the dealer. You pay only freight from our factory and local dealer charges.

We are not responsible for damage caused by accident, fire, flood, freezing, Act of God, misuse, misapplication, neglect, oxidizing agents (such as chlorine, ozone, chloramines and other related components), alteration, installation or operation contrary to our written instructions, or by the use of accessories or components which do not meet Culligan specifications, is not covered by this warranty. Refer to the specifications section in the Installation and Operating manual for application parameters.

Our product performance specifications are furnished with each water conditioning unit. TO THE EXTENT PERMITTED BY LAW, CULLIGAN DISCLAIMS ALL IMPLIED WARRANTIES, INCLUDING WITHOUT LIMITATION WARRANTIES OF MERCHANTABILITY AND FITNESS FOR PARTICULAR PURPOSE; TO THE EXTENT REQUIRED BY LAW, ANY SUCH IMPLIED WARRANTIES ARE LIMITED IN DURATION TO THE ONE-YEAR PERIOD SPECIFIED ABOVE FOR THE ENTIRE CONDITIONER. As a manufacturer, we do not know the characteristics of your water supply or the purpose for which you are purchasing a water conditioner. The quality of water supplies may vary seasonally or over a period of time, and your water usage rate may vary as well. Water characteristics can also differ considerably if your water conditioner is moved to a new location. For these reasons, we assume no liability for the determination of the proper equipment necessary to meet your requirements, and we do not authorize others to assume such obligations for us. Further, we assume no liability and extend no warranties, express or implied, for the use of this product with a non-potable water source. OUR OBLIGATIONS UNDER THIS WARRANTY ARE LIMITED TO THE REPAIR OR REPLACEMENT OF THE FAILED PARTS OF THE WATER CONDITIONER, AND WE ASSUME NO LIABILITY WHATSOEVER FOR DIRECT, INDIRECT, INCIDENTAL, CONSEQUENTIAL, SPECIAL, GENERAL, OR OTHER DAMAGES.

Some states do not allow the exclusion of implied warranties or limitations on how long an implied warranty lasts, so the above limitation may not apply to you. Similarly, some states do not allow the exclusion of incidental or consequential damages, so the above limitation or exclusion may not apply to you. This warranty gives you specific legal rights, and you may also have other rights which vary from state to state. Consult your telephone directory for your local independently operated Culligan dealer, or write Culligan International Company for warranty and service information.

Culligan International Company

9399 W. Higgins Road, Suite 1100
Rosemont, Illinois 60018
www.culligan.com



Notes